



WARNING: Failure to follow these warnings and the assembly instructions could result in serious injury or death.



WARNING: Read all instructions before assembling crib. Keep instructions for future use.



WARNING: Infants can suffocate on soft bedding. Never add a pillow or comforter. Never place additional padding under an infant.

- To reduce the risk of SIDS, pediatricians recommend healthy infants be placed on their backs to sleep, unless otherwise advised by your physician.
 - Strings can cause strangulation ! DO NOT place items with a string around a child's neck, such as hood strings or pacifier cords. DO NOT suspend strings over a crib or attach strings to toys.
 - To help prevent strangulation tighten all fasteners. A child can trap parts of the body or clothing on loose fasteners.
 - DO NOT place crib near window where cords from blinds or drapes may strangle a child.
 - When child is able to pull to a standing position, set mattress to lowest position and remove bumper pads, large toys, and other objects that could serve as steps for climbing out.
 - When child is able to climb out or reaches the height of 35 in.(90 cm), the crib shall no longer be used.
 - Check this product for damaged hardware, loose joints, missing parts or sharp edges before and after assembly and frequently during use. DO NOT use crib if any parts are missing, damaged or broken. Contact J&R Woodworking for replacement parts and instructional literature if needed. DO NOT substitute parts.
 - Never use plastic shipping bags or other plastic film as mattress covers because they can cause suffocation.
 - Infants can suffocate in gaps between crib sides and a mattress that is too small. Use a mattress that is at least 27 1/4 x 51 5/8 with a thickness not exceeding six inches.
- Follow warnings on all products in a crib.

MAINTENANCE AND CLEANING

- Caution: Periodically check the safety of your crib by making certain all screws, nuts and bolts are tightened securely. Call J&R Woodworking to replace any broken or missing parts. Do not substitute parts.
- If refinishing, use a non toxic finish specified for children's products.
- Your crib may be cleaned using a damp cloth with mild soap or a soft dry cloth. Avoid using furniture polish or cleaning agents that may be hazardous to children.

OPERATION AND STORAGE

- This crib is guaranteed to meet all federal and state standards and will provide you with many years of service provided you adhere to the guidelines for assembly, maintenance and operation.
 - Never aim a vaporizer or heating vent directly at the crib as this will damage the crib.
- Put these instructions in your hardware bag when done assembling the crib. Insert hardware bag into pouch on crib spring for further use.

Kid's Comfort Furniture

Your Source for Youth Furniture

4864 County Road 120

Millersburg OH 44654

330-893-0713

Kid's Comfort Manhattan Crib

Model #JR-4802

- 8—1 1/4" Connector Bolts (to fasten mattress support)
- 24- Internal tooth lock washers (for all connector bolts used on assembly of crib.)
- 8—3 1/4" Connector Bolts
- 8—2 1/2" Connector Bolts
- 1 - 4 mm Allen Wrench
- 1—Assembly Instruction

Note : Parts diagram on next page.

PARTS DIAGRAM PAGE

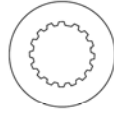

24 - Internal-tooth Lock Washers



1 - 4 mm Allen Wrench

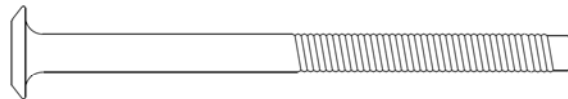

8 - 3 1/4" Connector Bolts

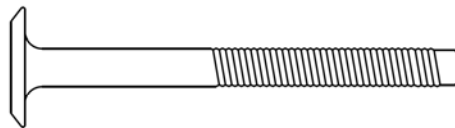

8 - 2 1/2" Connector Bolt

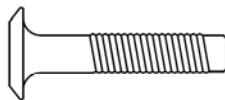

8 - 1 1/4" Connector Bolts

Instructions for assembling Manhattan Crib

Step 1 = Attaching posts to headboard & footboard

TOOLS & PARTS NEEDED FOR STEP 1



8—Internal-tooth Lock Washers



1—4 mm Allen Wrench

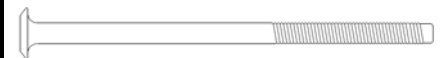

8—3 1/4" Connector Bolts

Double check to make sure your posts are turned correctly; if you turned them the wrong way it will appear like the inside of the crib is too long!!

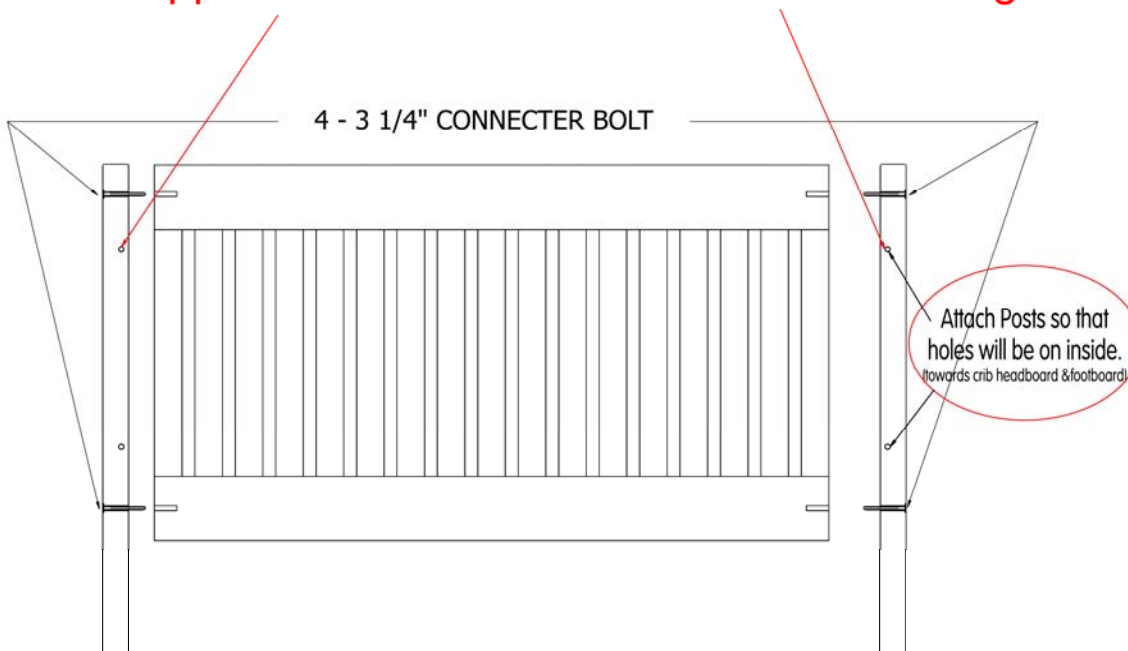

- Attach headboard posts to headboard by using 4 –3 1/4" connector bolts with lock washers included .**IMPORTANT !!! USE LOCK WASHERS PROVIDED**
- Repeat same step for other side panel.
- Tighten connector bolts with allen wrench provided. Make sure top of sides are even with top of posts
- Make sure all connector bolts are tightened snugly .(**IMPORTANT!!! DO NOT OVERTIGHTEN**)

Instructions for assembling Manhattan Crib

Step 2 = Attaching headboard to ends

2 1/2" Connector Bolts

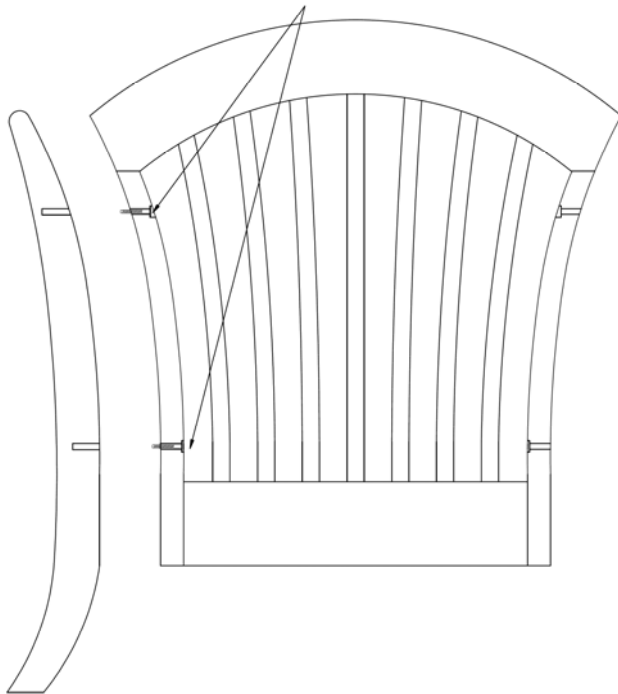

TOOLS & PARTS NEEDED FOR STEP 2



4—Internal-tooth Lock Washers



1—4 mm Allen Wrench

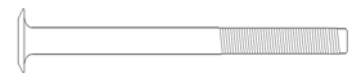

4—2 1/2" Connector Bolts

- Attach one end panel to headboard posts by using 2 – 2 1/2" connector bolts with lock washers included. **IMPORTANT !!! USE LOCK WASHERS PROVIDED**
- Repeat same step for other end panel.
- Tighten connector bolts with allen wrench provided.
- Make sure all connector bolts are tightened snugly. **(IMPORTANT!!! DO NOT OVERTIGHTEN)**

Maintenance and Cleaning

- Caution: Periodically Check the safety of your crib by making certain all screws and nuts are tightened securely. Call J&R Woodworking to replace any broken or missing parts. Do not substitute parts.
- Your crib may be cleaned using a damp cloth with mild soap or a soft dry cloth.
- Avoid using furniture polish or cleaning agents that may be hazardous to children.
- If refinishing, use only non-toxic finish specified for children's products.

Operation and Storage

This crib is guaranteed to meet all federal and state standards and will provide many years of service provided you adhere to the following guidelines for assembly, maintenance and operation. Never aim or point a vaporizer or humidifier directly at the crib. The water vapor will ruin the finish of the crib, as it would any other fine piece of furniture.

For parts or assistance call J&R Woodworking.

Disassemble and Storage:

1. Remove the crib mattress.
2. Follow the assembly instructions in reverse order starting with step 4.
3. Store your crib in a cool, dry place.

Instructions for assembling Manhattan Crib

Step 3 = Attaching crib mattress platform to crib

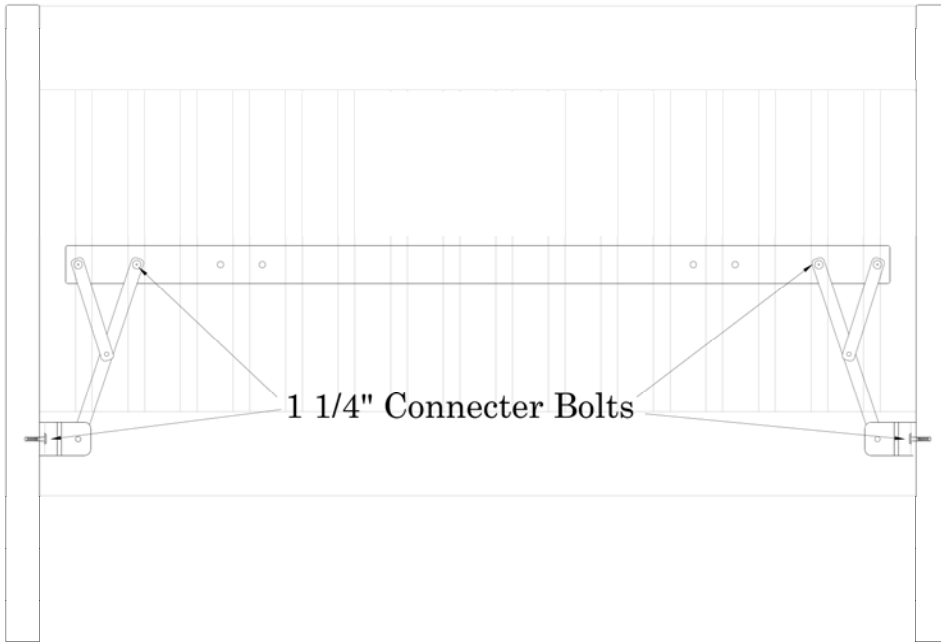

TOOLS & PARTS NEEDED FOR STEP 3



8— INTERNAL TOOTH LOCK
WASHERS

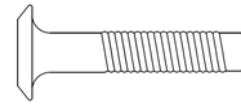

8— 1 1/4" CONNECTER BOLTS



1— 4 mm ALLEN WRENCH

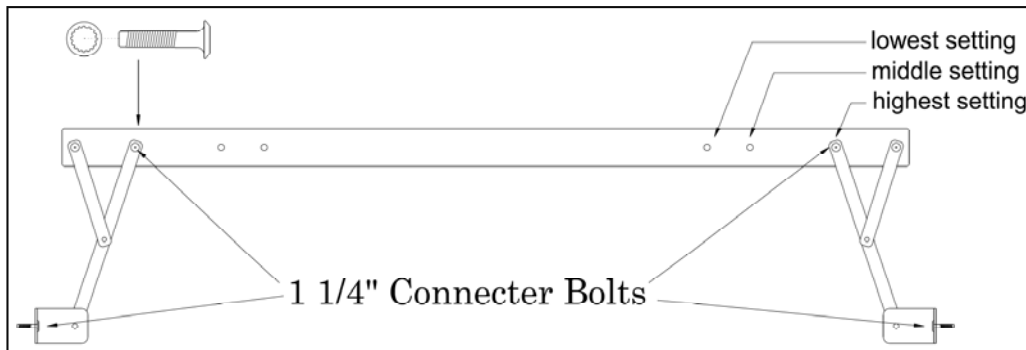

- Attach crib mattress platform to metal inserts on wood block mounted on crib ends.
- Use 4— 1 1/4" connector bolts with lock washers to attach each corner of crib mattress support .**IMPORTANT !!! USE LOCK WASHERS PROVIDED**
- Make sure all connector bolts are tightened snugly .(**IMPORTANT!!! DO NOT OVERTIGHTEN**)

**(CAUTION !!! ANY MATTRESS USED IN THIS CRIB
MUST BE AT LEAST 27 1/4 INCHES BY 51 5/8 INCHES
WITH A THICKNESS NOT EXCEEDING 6 INCHES.**

Instructions for assembling Manhattan Crib

Step 4 = Attaching footboard to ends

2 1/2" Connector Bolts

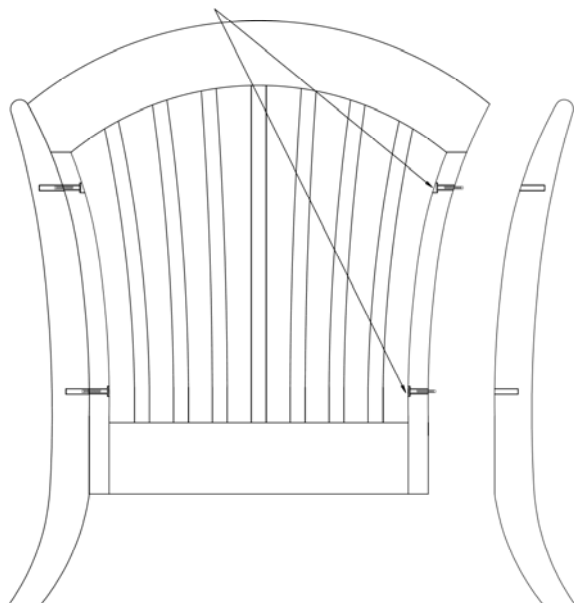

TOOLS & PARTS NEEDED FOR STEP 4



4—Internal-tooth Lock Washers



1—4 mm Allen Wrench

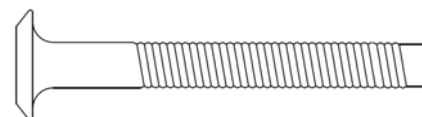

4—2 1/2" Connector Bolts

- Attach footboard to end panel by using 4 – 2 1/2" connector bolts with lock washers attached .**IMPORTANT !!!**
USE LOCK WASHERS PROVIDED
- Repeat same step for other end panel.
- Tighten connector bolts with allen wrench provided.
- Make sure all connector bolts are tightened snugly .(**IMPORTANT!!! DO NOT OVERTIGHTEN**)

Instructions for converting crib to youth bed

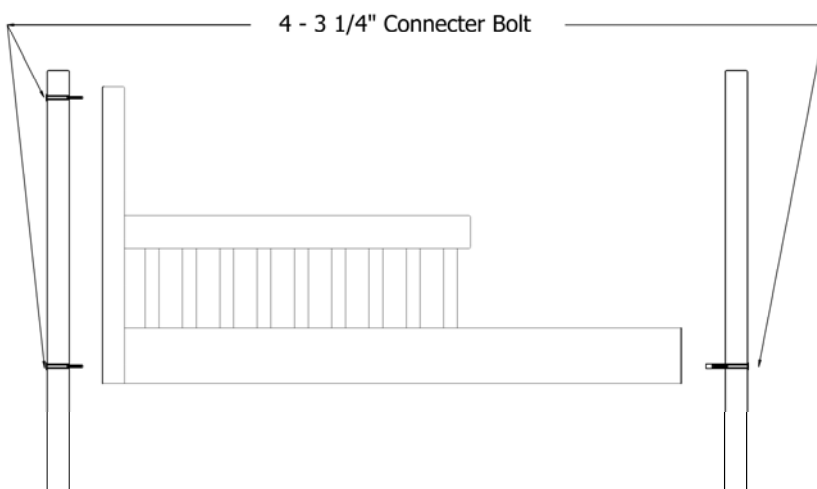

Tools & Parts Needed to Convert Crib into DayBed



4—Internal-tooth Lock
Washers



1—4 mm Allen Wrench

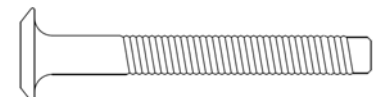

4—3 1/4" Connector Bolts

- Remove Footboard by unscrewing the four front 3 1/4" connector bolts from ends of footboard posts.
- Move crib mattress support to its lowest position.
- Attach safety board with four 3 1/4" bolts provided by inserting bolts through posts and turning bolts into inserts in conversion boards ends.

Instructions for converting daybed to full size bed

TOOLS AND PARTS NEEDED TO CONVERT CRIB TO FULL BED



8—Internal-tooth Lock Washers

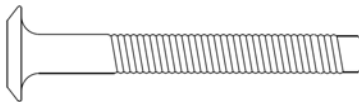

8—2 1/2" Connector Bolts



1—4 mm Allen Wrench

To Cover Holes...

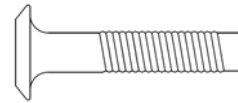

4—1 1/4" CONNECTER BOLTS

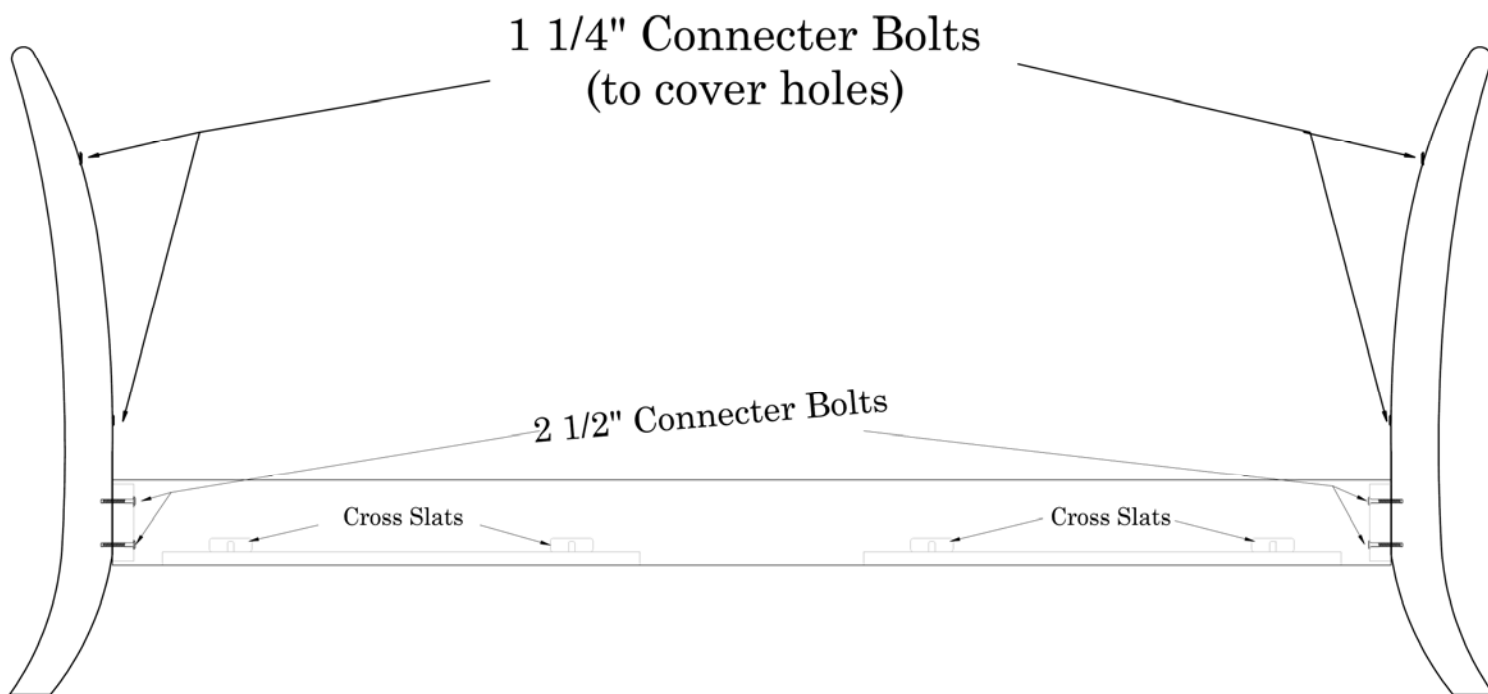

- Remove crib mattress support, conversion board, and two end panels.
- Attach bed rails to footboard by inserting 2 1/2" connector bolts through rail brackets into posts.
- Repeat same steps to attach headboard as footboard.
- Attach four cross slats by inserting cross slats (provided with your rails) over dowels that are on rails
- Cover the exposed holes in the headboard & footboard using the bolts as shown in the sketch above.