

# CASTLEBURY CRIB

## ASSEMBLY INSTRUCTIONS

MODEL#

SERIAL#

### **WARNING:**

*Failure to follow these warnings and the assembly instructions could result in serious injury or death.*

1.  **WARNING:** Infants can suffocate on soft bedding. Never add a pillow or comforter. Never place additional padding under an infant.
2. Read and familiarize yourself with all instructions before assembling crib and keep instruction for future use. DO NOT THROW THE INSTRUCTION BOOKLET AWAY.
3. DO NOT use crib if any parts are missing, broken or cracked. Before placing child in a previously used crib, inspect the crib for broken or bent brackets, loose joints, missing parts or sharp edges. Ask your dealer or write to Old Town Oak, LLC for replacement parts and an instruction sheet. Do not substitute parts, even as a temporary measure.
4. Strangulation Hazard: Strings can cause strangulation! Do not place items with a string around a child's neck, such as hood strings or pacifier cords. Do not suspend strings over a crib or attach strings to toys.
5. To help prevent strangulation tighten all fasteners. A child can trap parts of the body or clothing on loose fasteners.
6. DO NOT place crib near window where cords from blinds or drapes may strangle a child.
7. NEVER adjust spring level while baby is in the crib.
8. When child is able to pull to a standing position, set mattress to lowest position and remove bumper pads and large toys that could serve as steps to climb out.
9. DO NOT use a water mattress with this crib.
10. Crib should be inspected periodically to be sure it is being properly used and maintained. Rough use and excessive moving of the crib can cause some bolts to loosen. Loose bolts will cause parts failure and could cause a safety hazard. To ensure safety standards are maintained, crib should be properly assembled and used.
11. Articles with sharp edges or pointed ends should be kept away from the crib.
12. The use of furniture wax and polish should be avoided. The surface with which the baby can come in contact should be wiped clean using a damp cloth and a small amount of mild soap. DO NOT use strong detergents as they may be an irritant to the baby's skin. If refinishing, use a non-toxic finish specified for children's products.
13. This crib should be used as a sleeping place for infants-not as a cage or playpen for active children.
14. When child is able to climb out or reaches the height of 35 inches, the crib shall no longer be used. No two children are alike- and as the variance in children is great with respect to height, weight, agility and temperament- and as there is no certain age at which a child learns to stand or develops the desire or ability to climb out of it's crib- manufacturers of this crib cannot recommend a given age at which your child will have out-grown his or her crib.
15. NEVER use shipping or other bags as mattress covers, since these may cause suffocation.
16. When storing crib, carefully package all original parts to protect from loss or damage, and store all parts together.
17. Infants can suffocate in gaps between crib sides and a mattress that is too small.
18. To avoid head injury, DO NOT allow child to play underneath crib.
19. To reduce the risk of SIDS, pediatricians recommend healthy infants be placed on their backs to sleep, unless otherwise advised by your physician.
20. Follow warnings on all products in a crib.
21. **CAUTION: ANY MATTRESS USED IN THIS CRIB MUST BE AT LEAST 27 $\frac{1}{4}$ " BY 51 $\frac{5}{8}$ " WITH A THICKNESS NOT EXCEEDING 6 INCHES.**

## Step 1

# INSTRUCTIONS FOR ASSEMBLING CASTLEBURY CRIB

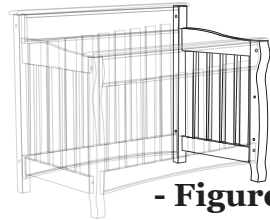
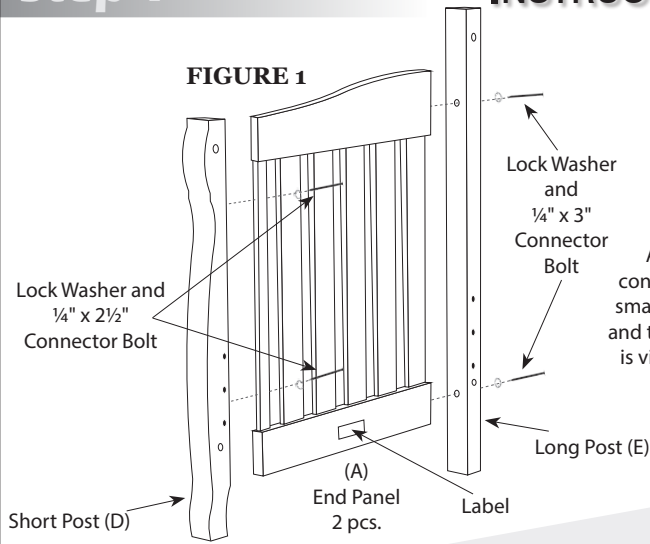

- Figure 1 -

Attach small end panels (A) to posts (D) with two  $\frac{1}{4}$ " x  $2\frac{1}{2}$ " connector bolts and two lock washers from the backside. Attach small end panels (A) to posts (E) with two  $\frac{1}{4}$ " x 3" connector bolts and two lock washers. Turn connector bolts snug. \*Make sure label is visible on the outside of the crib. The word "inside," located on bottom rails, should be on the inside of the crib.

**Do not over tighten!**

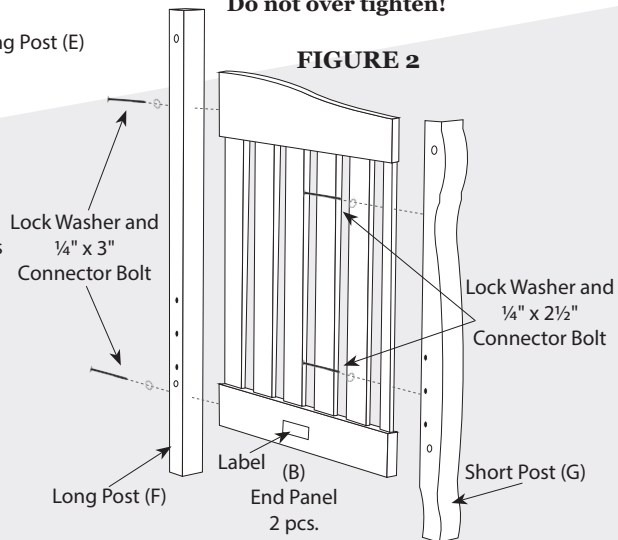
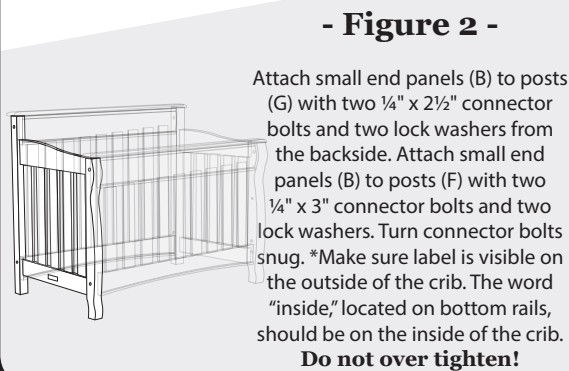

## Tools Needed:

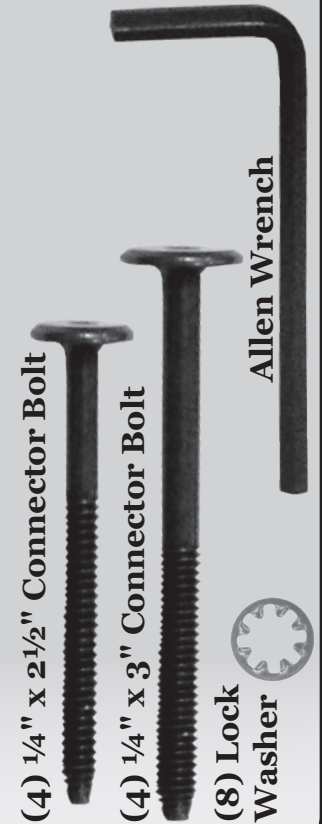

## Step 2

# INSTRUCTIONS FOR ASSEMBLING CASTLEBURY CRIB

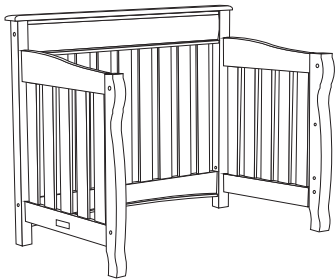

Attach posts (E, F) to ends of large back panel (B) with four  $\frac{1}{4}$ " x 3" connector bolts and four lock washers using allen wrench provided. Connector bolts screw into metal inserts in ends of panels. Turn connector bolts snug. The word "inside," located on bottom rails, should be on the inside of the crib.

**Do not over tighten!**

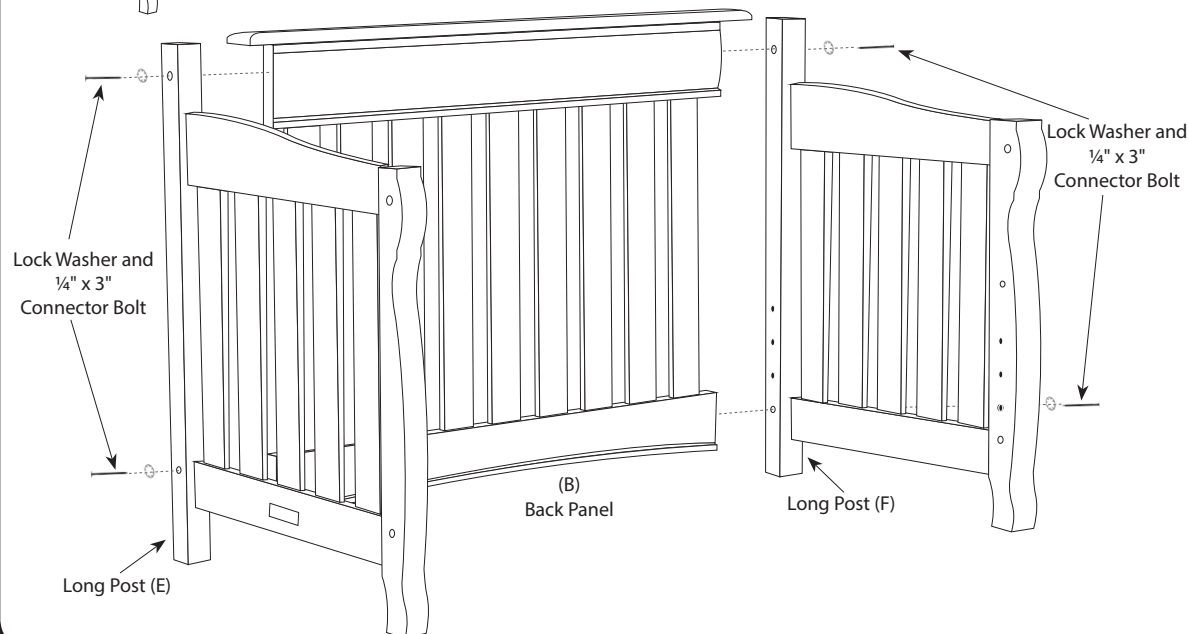

## Tools Needed:

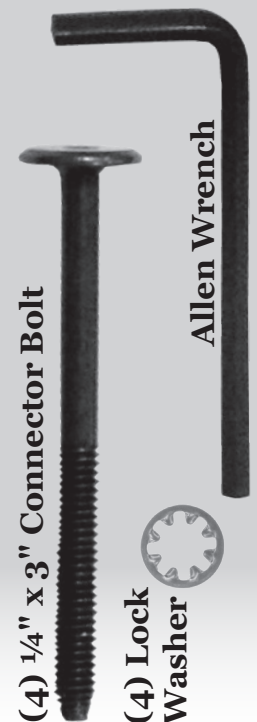

### Step 3

## INSTRUCTIONS FOR ASSEMBLING CASTLEBURY CRIB

Attach crib spring (H) to metal insert with four  $\frac{1}{4}$ " x 1" connector bolts and lock washers using Allen wrench provided. Small springs should be at top to support crib mattress. See figure 4. There are three metal inserts for height adjustment of crib spring. **Note:** Crib spring should be lowered as child grows to discourage child from trying to climb out. **DO NOT fasten the bolts all the way until you have completed step 4**

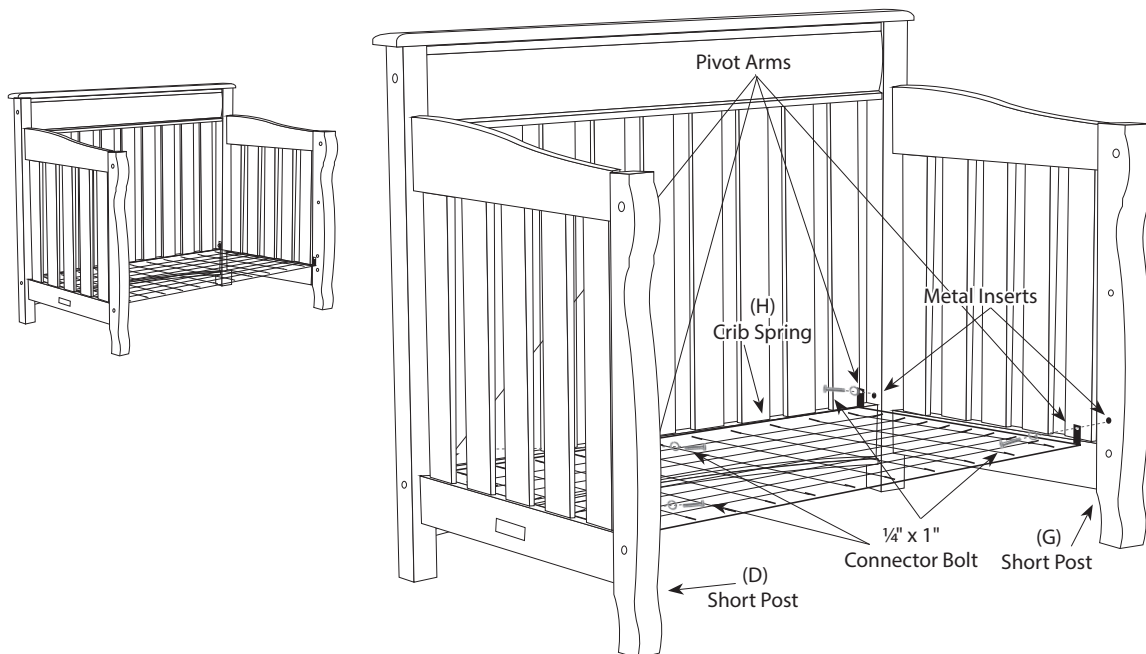

### Tools Needed:



### Step 4

## INSTRUCTIONS FOR ASSEMBLING CASTLEBURY CRIB

Attach small posts (D) to ends of front panel (C) with four  $\frac{1}{4}$ " x 3" connector bolts and lock washers as shown in figure 2, making sure to center panel on posts. Turn connector bolts snug. The word "inside," located on bottom rails, should be on the inside of the crib. **Now tighten crib spring bolt.**

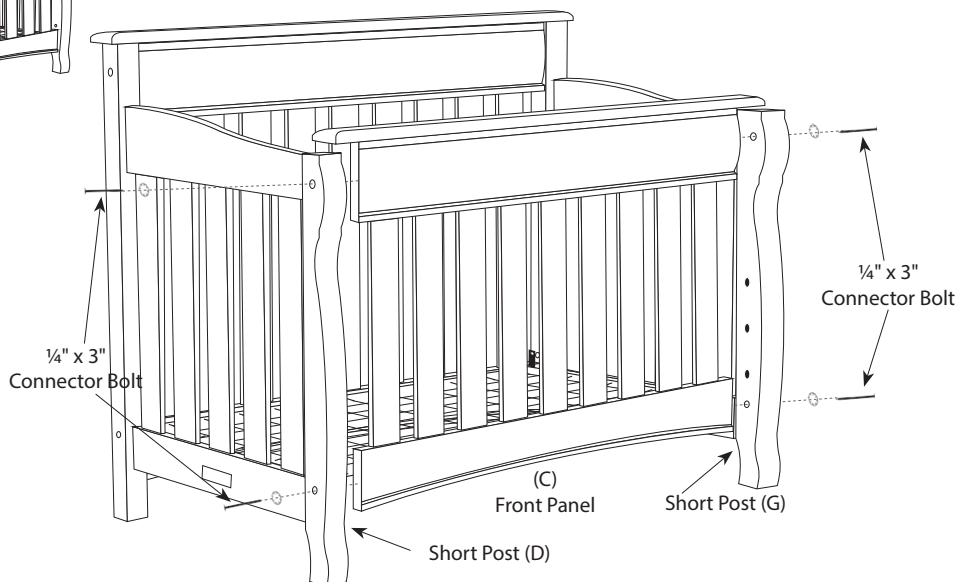
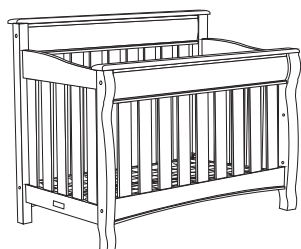

### Tools Needed:



Your crib is now ready for bedding.

**CAUTION: ANY MATTRESS USED IN THIS CRIB MUST BE AT LEAST 27 $\frac{1}{4}$ " BY 51 $\frac{5}{8}$ " WITH A THICKNESS NOT EXCEEDING 6 INCHES.**

## Step 5

## INSTRUCTIONS FOR CONVERTING CASTLEBURY CRIB TO TODDLER BED

1. Remove front panel by unscrewing four  $\frac{1}{4}$ " x 3" connector bolts. Store this panel in dry place for later use as footboard of double bed. Attach conversion board (I) to bottom hole on posts (D,G) with two  $\frac{1}{4}$ " x 3" connector bolts. Make sure crib spring (G) is set low enough to allow child to climb in and out of bed easily.

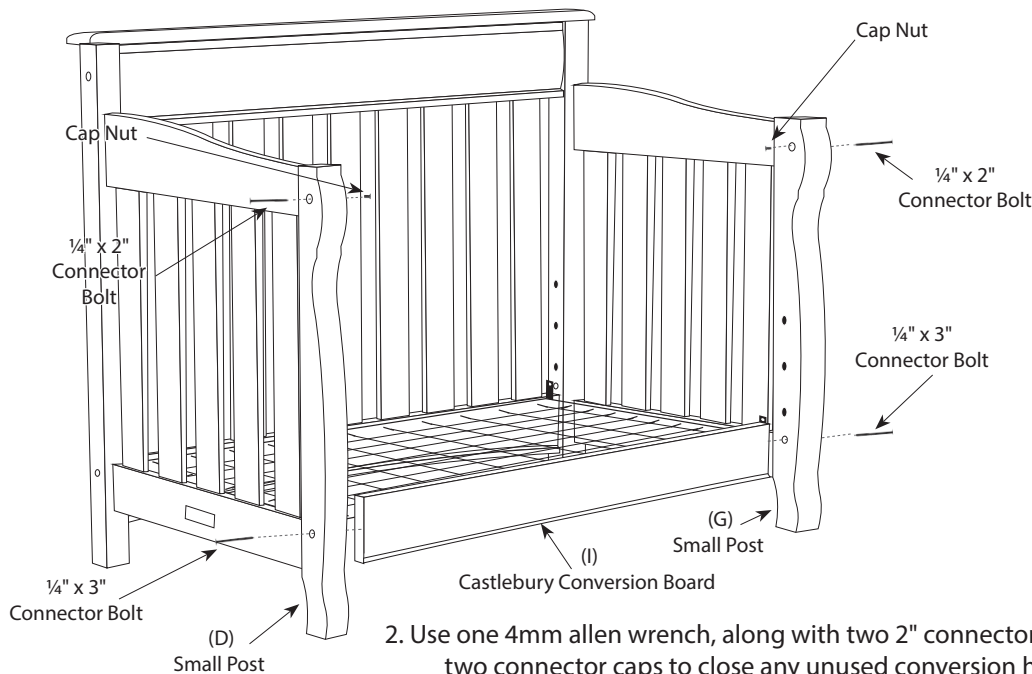

2. Use one 4mm allen wrench, along with two 2" connector bolts and two connector caps to close any unused conversion holes.

### Tools Needed:

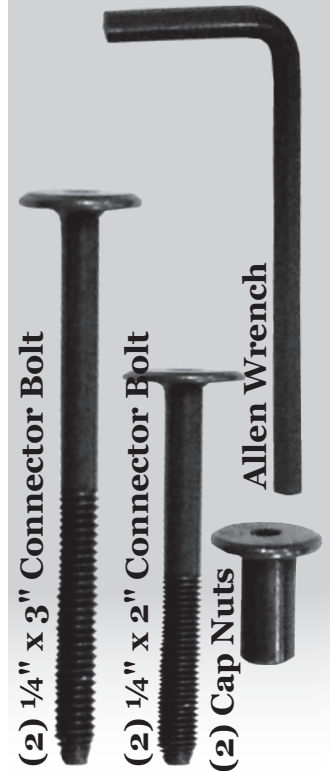

## Step 6

## INSTRUCTIONS FOR CONVERTING CASTLEBURY TODDLER BED TO DOUBLE BED

### Figure 1

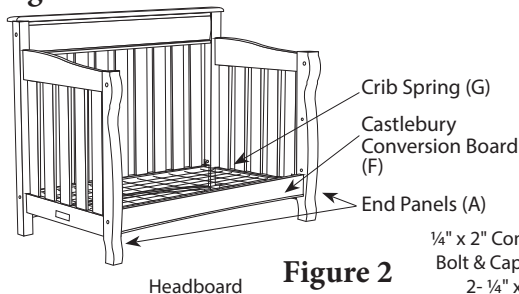

### Figure 1:

1. Remove crib spring (G), conversion board (F), two end panels (A) and cap nuts to bolts.

### Figure 2:

1. Attach front panel (C) to posts (D) with four  $\frac{1}{4}$ " x 3" connector bolts. This front panel is now the footboard of your double bed. Back panel (B) is the headboard of double bed.

2. Attach two double bed rails to posts (D) and (E) with two  $\frac{1}{4}$ " x  $2\frac{1}{2}$ " connector bolts to cap nuts and eight  $\frac{1}{4}$ " x 2" connector bolts. See Step 5. Holes are pre-drilled in posts (D) and (E).

3. Repeat Figure 2 to connect bed rails to posts.

4. Use one 4 mm allen wrench, along with four 2" connector bolts and four cap nuts to close any unused conversion holes.

### Tools Needed:

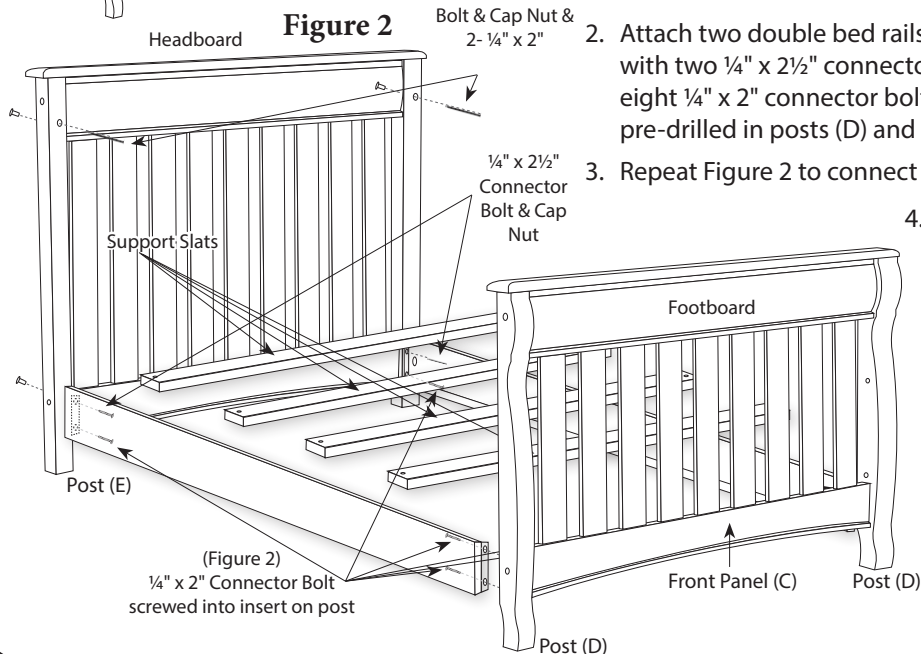
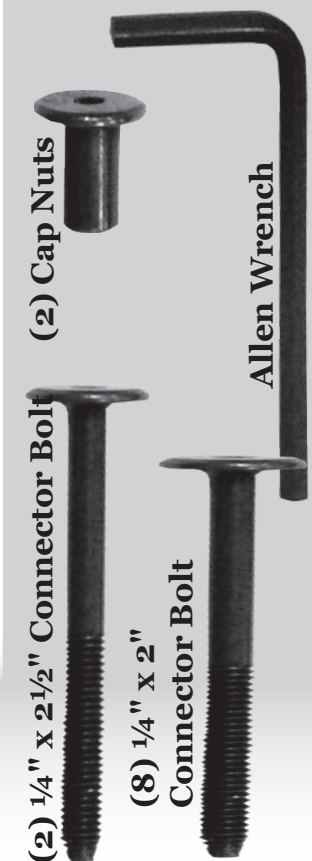

**OPERATION AND STORAGE:** For complete disassembly, reverse all steps and carefully wrap all pieces in padding to prevent scratching and denting. Store in a dry place.